



INSTRUCTIONS D'ASSEMBLAGE
ASSEMBLY INSTRUCTIONS

MONARCH
SPECIALTIES INC.

I 5910Q

LIT -
QUEEN / SIMILI-CUIR BRUN FONCE

BED -
QUEEN SIZE / DARK BROWN LEATHER-LOOK



**POUR DE L'ASSISTANCE OU POUR COMMANDER
DES PIÈCES CONTACTEZ NOTRE DÉPARTEMENT
DE SERVICE À LA CLIENTÈLE.**

**FOR ASSISTANCE OR TO ORDER PARTS
CONTACT OUR CUSTOMER SERVICE DEPARTMENT**

WWW.MONARCHSERVICE.COM

LISTE DES PIÈCES
PARTS LIST

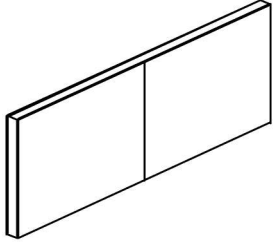
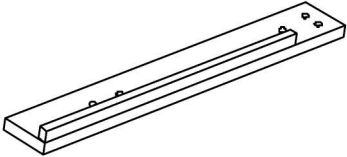
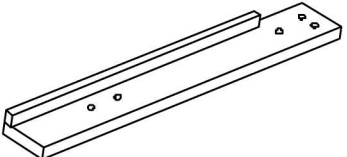
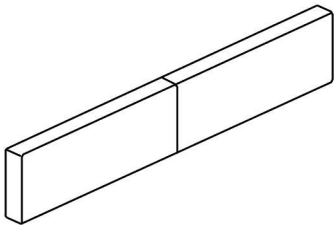
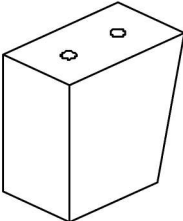
| PIÈCE / PART # | IMAGE | DESCRIPTION | QTY / QTÉ |
|----------------|---|--|-----------|
| 1 |  | HEADBOARD TÊTE DE LIT | 1 |
| 2 |  | FRONT FACING HEADBOARD LEFT LEG TÊTE DE LIT AVANT GAUCHE | 1 |
| 3 |  | FRONT FACING HEADBOARD RIGHT LEG TÊTE DE LIT AVANT DROITE | 1 |
| 4 |  | FOOTBOARD PIED DE LIT | 1 |
| 5 |  | FRONT FACING FOOTBOARD LEFT LEG PIED DE LIT AVANT GAUCHE | 1 |

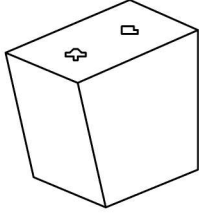
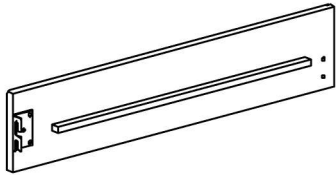
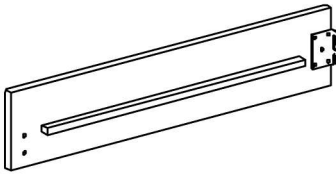
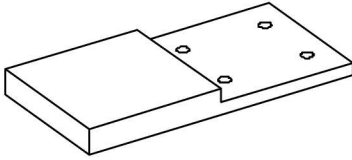
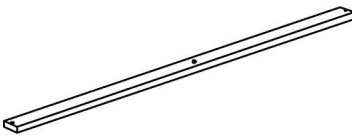

LISTE DES PIÈCES
PARTS LIST

| PIÈCE / PART # | IMAGE | DESCRIPTION | QTY / QTÉ |
|----------------|---|---|-----------|
| 6 |  | <p>FRONT FACING FOOTBOARD RIGHT LEG PIED DE LIT AVANT DROIT</p> | 1 |
| 7 |  | <p>FRONT FACING LEFT SIDE RAIL RAIL DE CÔTÉ GAUCHE</p> | 2 |
| 8 |  | <p>FRONT FACING RIGHT SIDE RAIL RAIL DE CÔTÉ DROIT</p> | 2 |
| 9 |  | <p>SIDE RAIL SUPPORT LEG RAIL DE CÔTÉ PATTE DE SOUTIENT</p> | 2 |
| 10 |  | <p>SLAT LAMELLE</p> | 4 |

LISTE DES PIÈCES
PARTS LIST

| PIÈCE / PART # | IMAGE | DESCRIPTION | QTY / QTÉ |
|----------------|---|---------------------------------|-----------|
| 11 |  | SUPPORT LEG PATTE DE SOUTIEN | 4 |

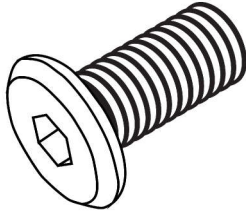
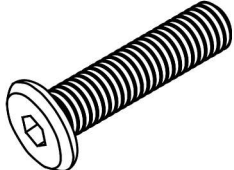
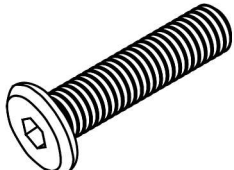
LISTE DES PIÈCES DE MONTAGE
HARDWARE LIST

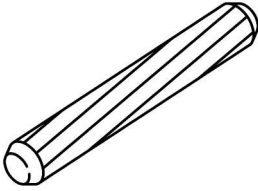
| PIÈCE / PART # | IMAGE | DESCRIPTION | QTY / QTÉ |
|----------------|---|--|-----------|
| A |  | ASSEMBLING BOLT - Ø 3/8" X 3/4" BOULON D'ASSEMBLAGE - Ø 3/8" X 3/4" | 8 |
| B |  | ASSEMBLING BOLT - Ø 1/4" X 7/8" BOULON D'ASSEMBLAGE - Ø 1/4" X 7/8" | 8 |
| C |  | ASSEMBLING BOLT - Ø 1/4" X 1 3/8" BOULON D'ASSEMBLAGE - Ø 1/4" X 1 3/8" | 10 |
| D |  | ASSEMBLING BOLT - Ø 1/4" X 2 3/4" BOULON D'ASSEMBLAGE - Ø 1/4" X 2 3/4" | 2 |
| E |  | WOOD DOWEL GOUJON DE BOIS | 2 |

LISTE DES PIÈCES DE MONTAGE
HARDWARE LIST

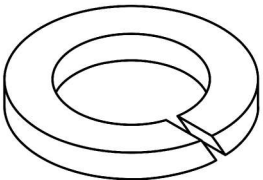
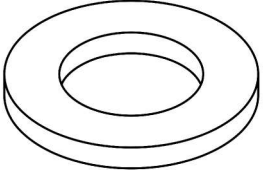
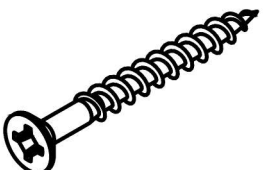
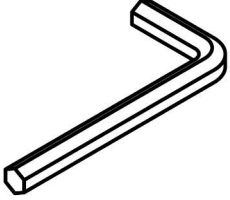
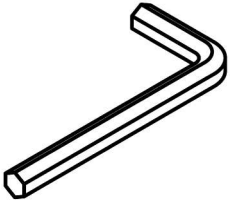
| PIÈCE / PART # | IMAGE | DESCRIPTION | QTY / QTÉ |
|----------------|---|--|-----------|
| F |  | LOCK WASHER ENTRETOISE DE MÉTAL | 14 |
| G |  | METAL WASHER RONDELLE DE MÉTAL | 14 |
| H |  | ASSEMBLING SCREW - Ø 1/8" X 1 1/4" VIS D'ASSEMBLAGE - Ø 1/8" X 1 1/4" | 8 |
| I |  | HEX KEY - M5 , 4MM CLÉ HEXAGONALE - M5 , 4MM | 1 |
| J |  | HEX KEY - M4 , 3MM CLÉ HEXAGONALE - M4 , 3MM | 1 |

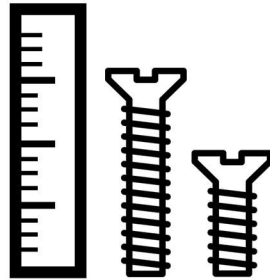

OUTIL DE VÉRIFICATION DE DIMENSIONS DES PIÈCES
HARDWARE DIMENSIONS VERIFICATION TOOL

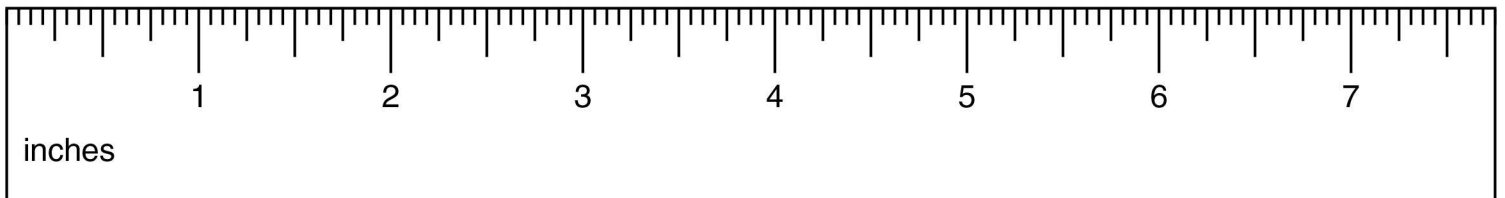

ÉTAPE / STEP 1

La quincaillerie et les composants sont situés dans l'unité de la tête de lit.

Hardware and components are located in the headboard unit.

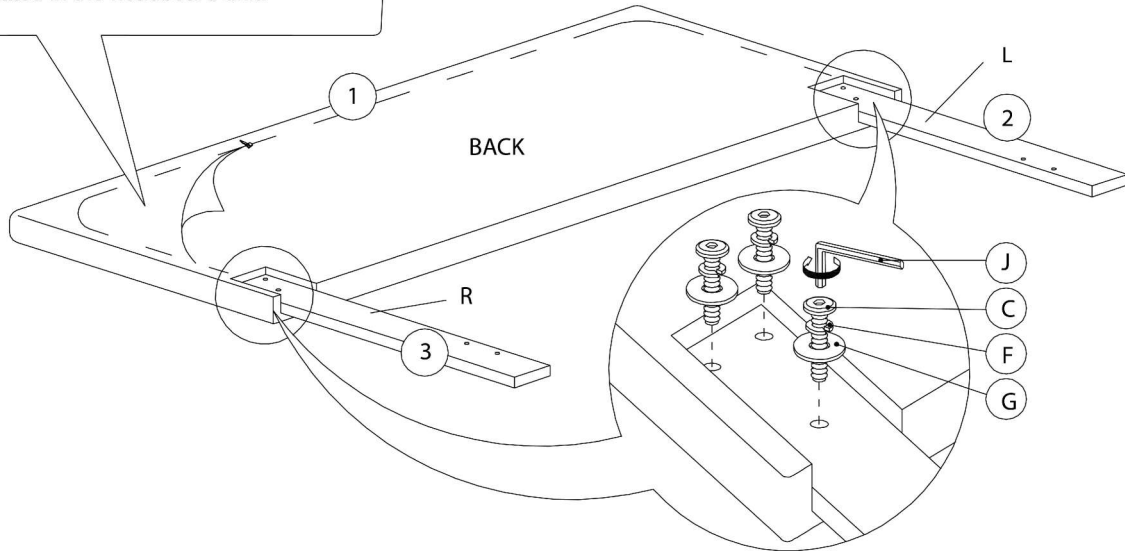

ÉTAPE / STEP 2

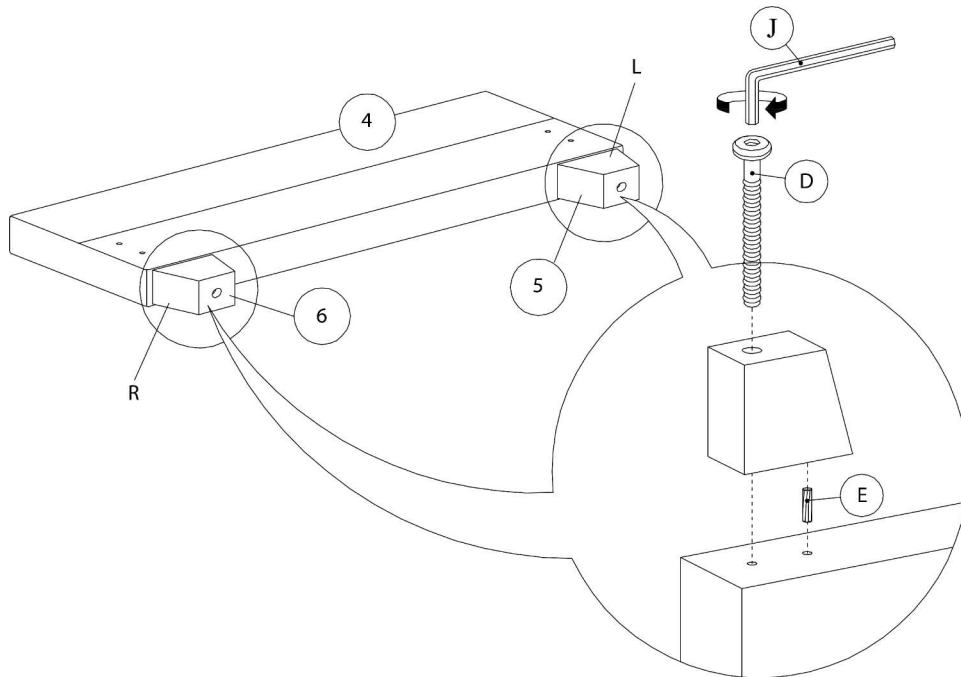

ÉTAPE / STEP 3

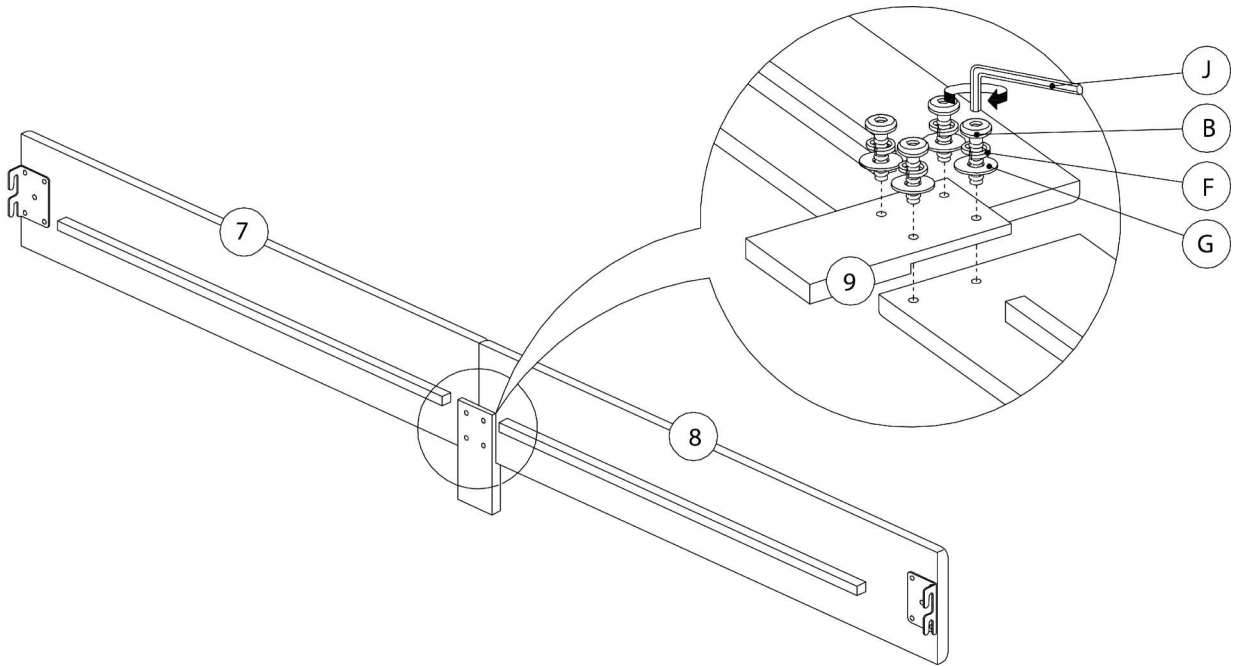

ÉTAPE / STEP 4

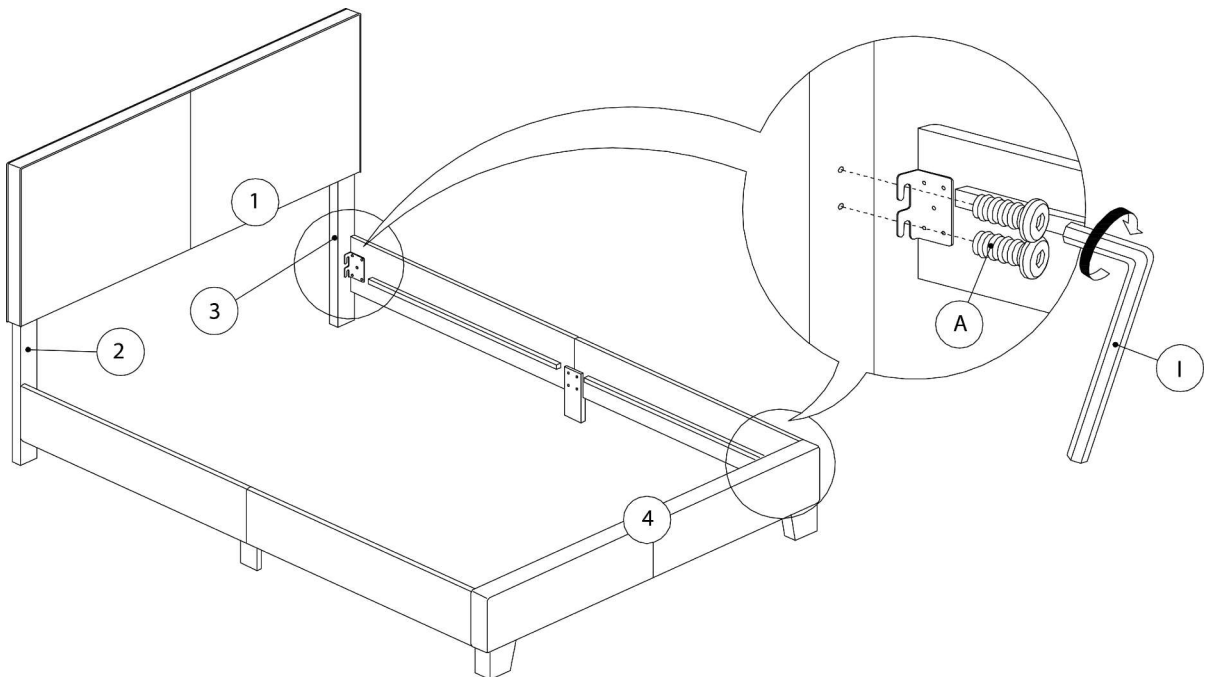

ÉTAPE / STEP 5

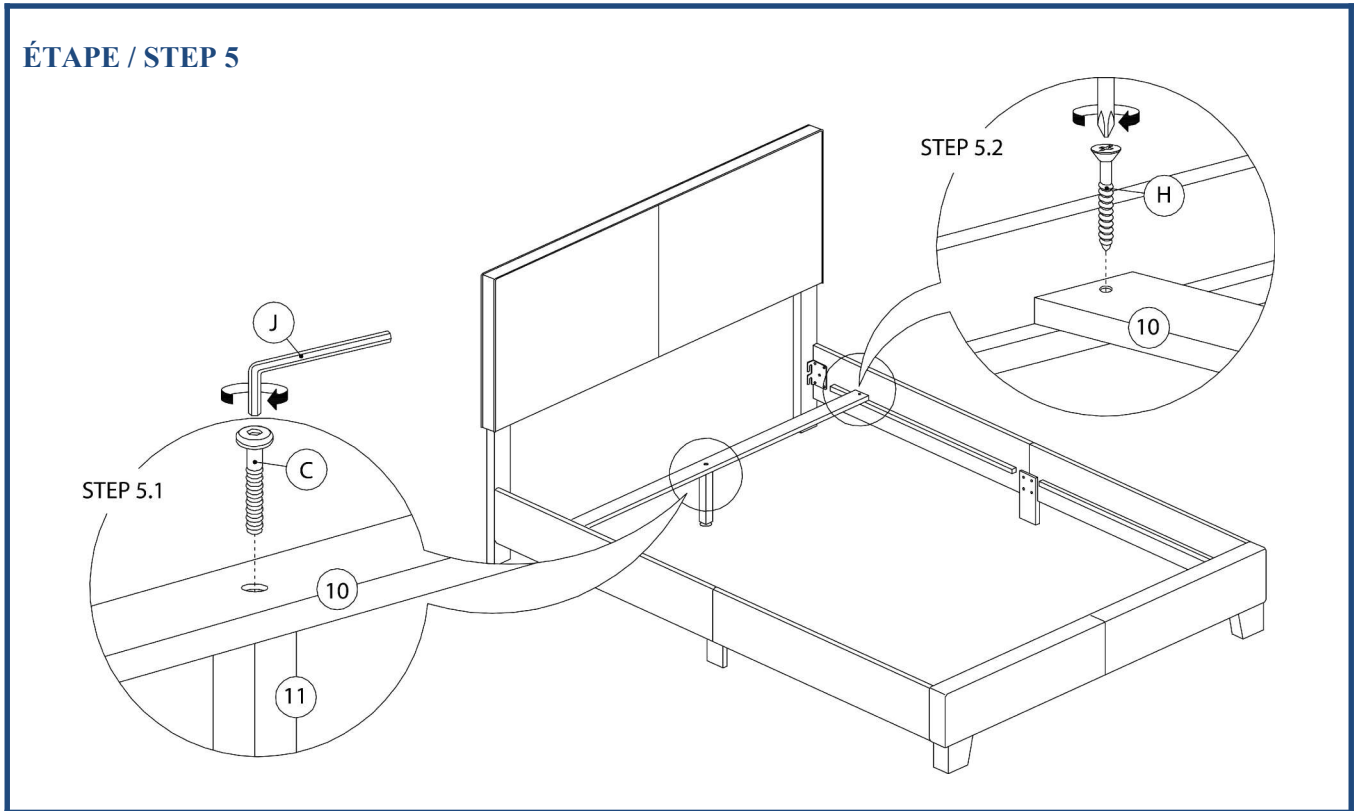

ÉTAPE / STEP 6

